

**Electrical / Environmental**

# HM33

## Current Sense Surface Mount Transformers

- Insulation Resistance, Minimum 10 MΩ
- Operating Temperature Range -40°C to + 130°C
- Insulation System Class B, 130°C

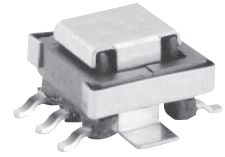

**Specifications @ 25°C**

Part Number	Turns N1:N2 @ 10 kHz	Secondary Inductance μH Min.	Primary DCR mΩ Max.	Secondary DCR Ω Max.	Primary Amps Max.	Pin 1 Marking Color Code	H10XXXLF ID Code
HM33-10125LF	1:125	3000	5.0	7.36	10	White	-
HM33-10100LF	1:100	2000	5.0	5.50	10	Black	-
HM33-10070LF	1:70	980	5.0	4.75	10	Yellow	-
HM33-10050LF	1:50	500	5.0	2.50	10	Green	-
HM33-10040LF	1:40	320	5.0	1.35	10	Blue	-
HM33-10030LF	1:30	180	5.0	1.00	10	Red	-
HM33-H10125LF	1:125	3000	0.75	7.36	20	White	A
HM33-H10100LF	1:100	2000	0.75	5.50	20	Black	B
HM33-H10070LF	1:70	980	0.75	4.75	20	Yellow	C
HM33-H10050LF	1:50	500	0.75	2.50	20	Green	D
HM33-H10040LF	1:40	320	0.75	1.35	20	Blue	E
HM33-H10030LF	1:30	180	0.75	1.00	20	Red	F

**Outline Dimensions (Inch/mm)**

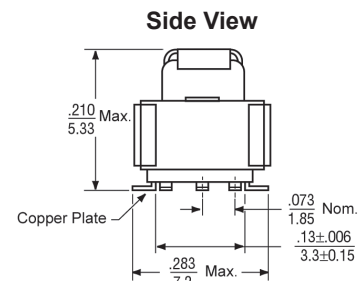
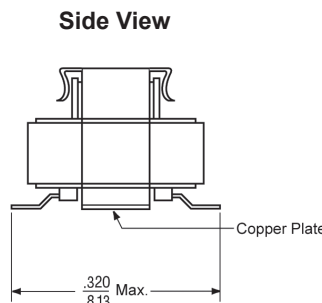
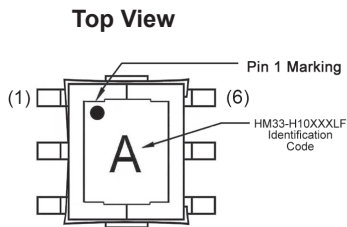

**Bottom View**

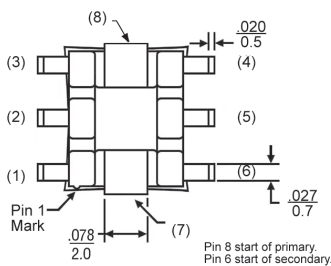

**Recommended Solder Pad Layout**

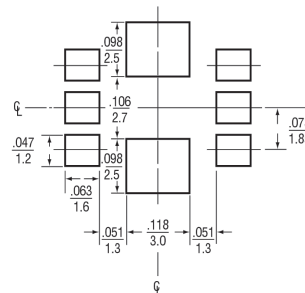

**Schematic**

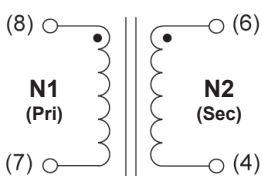

**Ordering Information**

